

Nominal data

Type	618 NN	
Nominal voltage	VDC	48
Nominal voltage range	VDC	36 .. 56
Speed	min ⁻¹	5100
Power input	W	2.1
Min. ambient temperature	°C	-20
Max. ambient temperature	°C	65
Air flow	m ³ /h	42
Sound power level	B	5.0
Sound pressure level	dB(A)	35

ml = Max. load · me = Max. efficiency · fa = Running at free air · cs = Customer specs · cu = Customer unit
Subject to alterations

Technical features

Mass	0.066 kg
Dimensions	60 x 60 x 25 mm
Material of impeller	Fibreglass-reinforced PA plastic
Housing material	Fibreglass-reinforced PBTP plastic
Direction of air flow	Air exhaust over bars
Direction of rotation	Right, looking at rotor
Bearing	Ball bearings
Lifetime L10 at 40 °C	70000 h
Lifetime L10 at maximum temperature	40000 h
Connection line	Single strands AWG 22, TR 64, bared and tin-plated.
Motor protection	Protected against reverse polarity and locking.
Locked-rotor protection	With electronic blocking and overload protection
Approval	VDE, CSA, UL, CE
Option	Special options: Speed signal Go / No-go alarm Moisture protection Protection rating: IP 54 / IP 68

618 NN

DC axial compact fan

Product drawing

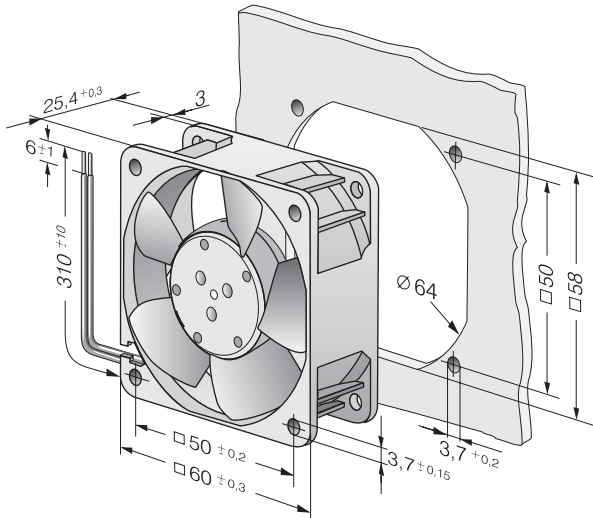

Charts: Air flow

